



public

Compact Performance

TYPES 437, 438, 439, 481

disclosure cat.:	I	proofread:	KUW	published date:	9/15/11	effect. date:	05.2011
author:	Niehus	released by:	KUW	replaces:	0	status:	published
resp. depart.:	PP	date of release:	05.2011	revision No.:	1		
doc. type:	LGS	change rep. No.:	00779A	retention period:	10y.		

Global Standard	LESER Global Standard	LGS 4100
	Assembly instructions for types 437, 438, 439, 481	Page 2/41

Contents

1	Purpose	2
2	Scope	2
3	References	2
4	Disclaimer	2
5	Qualified fitting personnel	3
6	General Information	3
7	General illustration	4
8	Assembly of the Compact Performance series	5
8.1	Assembly of the adjusting screw.....	5
8.2	Assembly of the spindle / disc assembly	6
8.3	Assembly of the inlet body and outlet body	24
8.4	Adjusting the set pressure	31
8.5	Testing and documenting the seat tightness.....	32
8.6	Assembly of the cap and lever.....	33
8.7	Testing the seal tightness to the outside.....	39
8.8	Sealing the valve	41

1 Purpose

This LESER Global Standard (LGS) is assembly documentation for various assembly scenarios for LESER safety valves of the Compact Performance series. The required work steps and tools are described.

2 Scope

This document must be applied to the assembly of Compact Performance safety valves in agencies and subsidiaries of LESER GmbH & Co. KG.

3 References

- LGS 0201 (LWN 220.01)
- LGS 3322 (LWN 322-03)
- LGS 3614 (LWN 614-08)

Note: LESER LWN standards will be replaced by LGS, latest editions apply.

4 Disclaimer

LESER puts in a great deal of effort into making up-to-date and correct documentation available. Nevertheless, LESER GmbH & Co. KG gives no guarantee that the recommended actions presented here are entirely correct and error free.

disclosure cat.:	I	proofread:	KUW	published date:	9/15/11	effect. date:	05.2011
author:	Niehus	released by:	KUW	replaces:	0	status:	published
resp. depart.:	PP	date of release:	05.2011	revision No.:	1		
doc. type:	LGS	change rep. No.:	00779A	retention period:	10y.		

public

Global Standard	LESER Global Standard	LGS 4100
	Assembly instructions for types 437, 438, 439, 481	Page 3/41

This document is to be applied exclusively to the specified type. LESER GmbH & Co. KG declines any liability or responsibility for the correctness and completeness of the content.

LESER GmbH & Co. KG reserves the right to change the information contained in this document, which is for the products of LESER GmbH & Co. KG and is intended for LESER subsidiaries, at any time and without prior announcement.

LESER GmbH & Co. KG is available to the users of this document to provide additional information.

5 Qualified fitting personnel

The assembly of LESER safety valves may only be performed by trained or qualified fitters. The qualifications must be obtained through the appropriate training measures.

6 General Information



- Gloves must be worn during the entire assembly.

disclosure cat.:	I	proofread:	KUW	published date:	9/15/11	effect. date:	05.2011
author:	Niehus	released by:	KUW	replaces:	0	status:	published
resp. depart.:	PP	date of release:	05.2011	revision No.:	1		
doc. type:	LGS	change rep. No.:	00779A	retention period:	10y.		

Global Standard	LESER Global Standard	LGS 4100
	Assembly instructions for types 437, 438, 439, 481	Page 4/41

7 General illustration

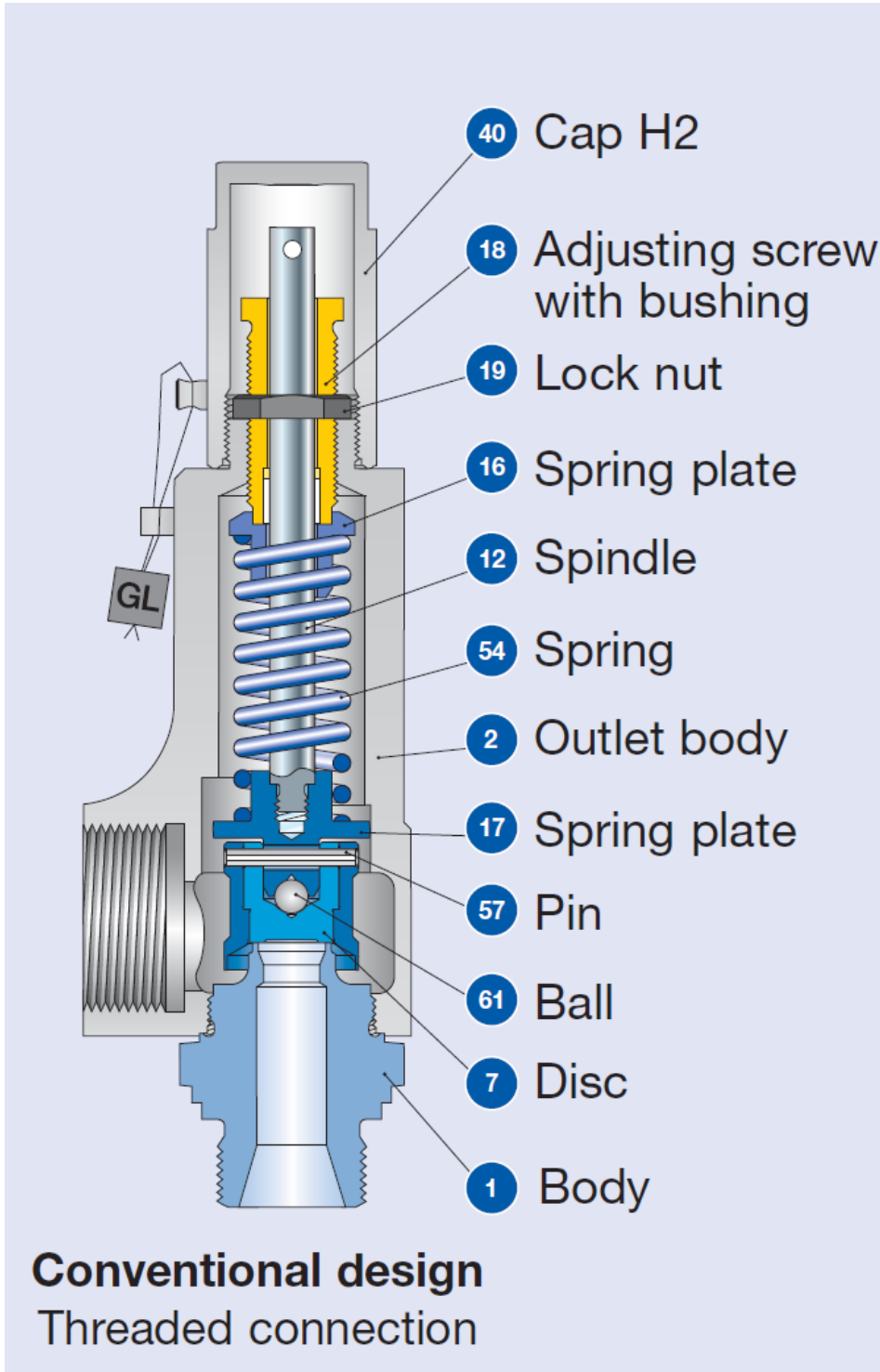

public



Figure 7-1: Type 437

disclosure cat.:	I	proofread:	KUW	published date:	9/15/11	effect. date:	05.2011
author:	Niehus	released by:	KUW	replaces:	0	status:	published
resp. depart.:	PP	date of release:	05.2011	revision No.:	1		
doc. type:	LGS	change rep. No.:	00779A	retention period:	10y.		

Global Standard	LESER Global Standard	LGS 4100
	Assembly instructions for types 437, 438, 439, 481	Page 5/41

8 Assembly of the Compact Performance series

8.1 Assembly of the adjusting screw

Illustration	Description	Tool / aid
 <p>Figure 8.1-1</p>	Assemble the adjusting screw (incl. PTFE-bushing inside) and lock nut.	
 <p>Figure 8.1-2</p>	Grease the adjusting screw on the thread and end face.	Brush Halocarbon (OI-56 S / 60H)
 <p>Figure 8.1-3</p>	Screw the adjusting screw into the outlet body (a few turns)	

public



disclosure cat.:	I	proofread:	KUW	published date:	9/15/11	effect. date:	05.2011
author:	Niehus	released by:	KUW	replaces:	0	status:	published
resp. depart.:	PP	date of release:	05.2011	revision No.:	1		
doc. type:	LGS	change rep. No.:	00779A	retention period:	10y.		

Global Standard	LESER Global Standard	LGS 4100
	Assembly instructions for types 437, 438, 439, 481	Page 6/41

8.2 Assembly of the spindle / disc assembly

8.2.1 Metallic seal 437



8.2.1.1 Spindle / spring plate assembly

Illustration	Description	Tool / aid
 <p>Figure 8.2.1.1-1</p>	Put the spring plate into the assembly device and fasten in place with bench vice.	Assembly device, Bench vice
 <p>Figure 8.2.1.1-2</p>	Put a very small amount of glue on the spindle thread (1 drop on the thread).	Glue DELO ML 5449

public

disclosure cat.:	I	proofread:	KUW	published date:	9/15/11	effect. date:	05.2011
author:	Niehus	released by:	KUW	replaces:	0	status:	published
resp. depart.:	PP	date of release:	05.2011	revision No.:	1		
doc. type:	LGS	change rep. No.:	00779A	retention period:	10y.		

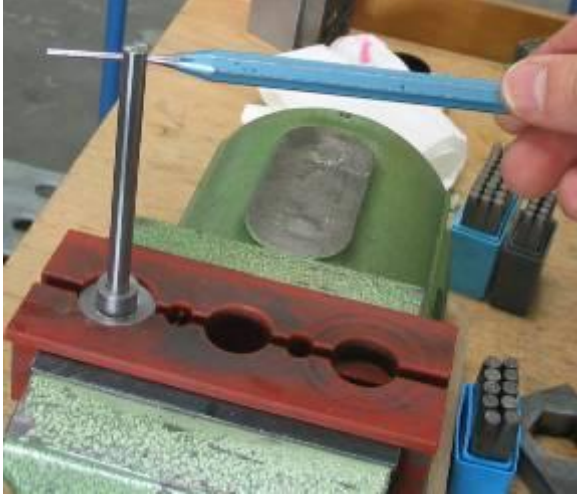
Global Standard	LESER Global Standard	LGS 4100
	Assembly instructions for types 437, 438, 439, 481	Page 7/41



Illustration	Description	Tool / aid
 <p>Figure 8.2.1.1-3</p>	<p>Put the spindle thread in the lower spring plate and screw it in until it is tight to the touch. Push the pin punch through the spindle hole and screw in until it is tight to the touch.</p>	
 <p>Figure 8.2.1.1-4</p>	<p>Roundness check of the spindle/disc assembly Tolerance: max. 0.2mm</p> <p style="text-align: center;"></p>	<p>Indicating calliper device</p>

public

disclosure cat.:	I	proofread:	KUW	published date:	9/15/11	effect. date:	05.2011
author:	Niehus	released by:	KUW	replaces:	0	status:	published
resp. depart.:	PP	date of release:	05.2011	revision No.:	1		
doc. type:	LGS	change rep. No.:	00779A	retention period:	10y.		

Global Standard	LESER Global Standard	LGS 4100
	Assembly instructions for types 437, 438, 439, 481	Page 8/41



8.2.1.2 Assembly installation

Illustration	Description	Tool / aid
 <p>Figure 8.2.1.2-1</p>	<p>Visual check: Check sealing surface for cleanliness and damage. Sharpen the pin.</p>	
 <p>Figure 8.2.1.2-2</p>	<p>Assemble the disc body and lifting aid (holes matching each other).</p>	
 <p>Figure 8.2.1.2-3</p>	<p>Insert the ball.</p>	

public

disclosure cat.:	I	proofread:	KUW	published date:	9/15/11	effect. date:	05.2011
author:	Niehus	released by:	KUW	replaces:	0	status:	published
resp. depart.:	PP	date of release:	05.2011	revision No.:	1		
doc. type:	LGS	change rep. No.:	00779A	retention period:	10y.		

Global Standard	LESER Global Standard	LGS 4100
	Assembly instructions for types 437, 438, 439, 481	Page 9/41

Illustration	Description	Tool / aid
 <p>Figure 8.2.1.2-4</p>	<p>Assemble the spindle with the spring plate into the preassembled parts and place them on the aligning punch in the device.</p>	<p>- Aligning punch, Device</p>
 <p>Figure 8.2.1.2-5</p>	<p>Install the pin using a lever press.</p>	<p>- Lever press</p>

public

disclosure cat.:	I	proofread:	KUW	published date:	9/15/11	effect. date:	05.2011
author:	Niehus	released by:	KUW	replaces:	0	status:	published
resp. depart.:	PP	date of release:	05.2011	revision No.:	1		
doc. type:	LGS	change rep. No.:	00779A	retention period:	10y.		

Global Standard	LESER Global Standard	LGS 4100
	Assembly instructions for types 437, 438, 439, 481	Page 10/41

Illustration	Description	Tool / aid
 <p>Figure 8.2.1.2-6</p>	<p>Spring plate and spindle assembled.</p>	
 <p>Figure 8.2.1.2-7</p>	<p>Install the spring and top spring plate on the spindle.</p> <p>Only for thrust bearings: Spring, top spring plate, thrust bearings, bearing washer Grease thrust bearing.</p>	<p>Brush, Halocarbon (OI-56 S / 60H)</p>



public

disclosure cat.:	I	proofread:	KUW	published date:	9/15/11	effect. date:	05.2011
author:	Niehus	released by:	KUW	replaces:	0	status:	published
resp. depart.:	PP	date of release:	05.2011	revision No.:	1		
doc. type:	LGS	change rep. No.:	00779A	retention period:	10y.		

Global Standard	LESER Global Standard	LGS 4100
	Assembly instructions for types 437, 438, 439, 481	Page 11/41

8.2.2 Plastic sealing plate 437

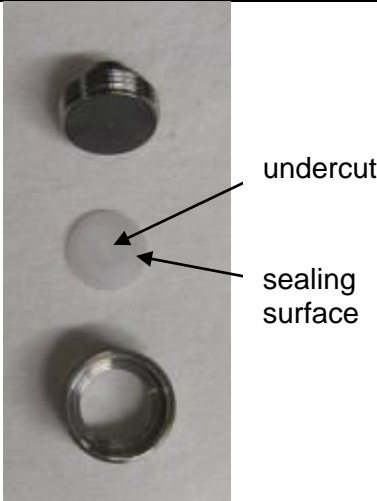

8.2.2.1 Disc assembly

Illustration	Description	Tool / aid
 <p>undercut sealing surface</p> <p>Figure 8.2.2.1-1</p>	Visual check: Check sealing surface of the sealing plate (outer ring surface) for cleanliness and damage.	
 <p>Figure 8.2.2.1-2</p>	Visual check: Check the evenness of the sealing plate (front and back side, no burrs permitted).	
 <p>Figure 8.2.2.1-3</p>	Screw disc body into the lifting aid hand tight with fixing the sealing plate inside. Clamp parts at lifting aid in device.	Clamping block, Device

public

disclosure cat.:	I	proofread:	KUW	published date:	9/15/11	effect. date:	05.2011
author:	Niehus	released by:	KUW	replaces:	0	status:	published
resp. depart.:	PP	date of release:	05.2011	revision No.:	1		
doc. type:	LGS	change rep. No.:	00779A	retention period:	10y.		

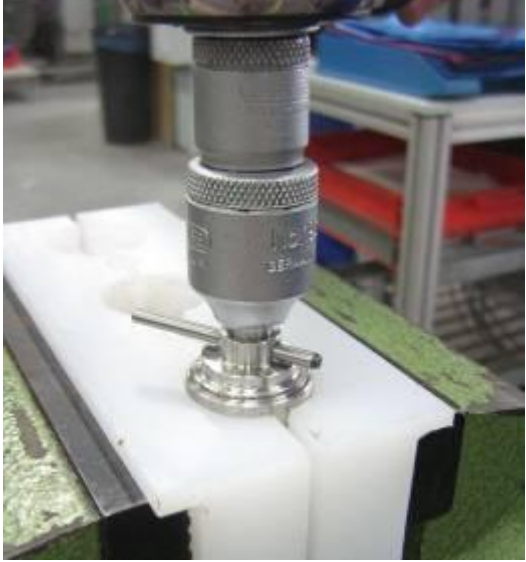
Global Standard	LESER Global Standard	LGS 4100
	Assembly instructions for types 437, 438, 439, 481	Page 12/41



Illustration	Description	Tool / aid
 <p>Figure 8.2.2.1-4</p>	<p>Tighten the disc body with the special spanner socket using 4 Nm.</p>	 <p>Special spanner socket Torque wrench</p>
 <p>Figure 8.2.2.1-5</p>	<p>Mark the material codes of sealing plate into the lifting aid.</p>	<p>Punch numbers, Hammer</p>

public

disclosure cat.:	I	proofread:	KUW	published date:	9/15/11	effect. date:	05.2011
author:	Niehus	released by:	KUW	replaces:	0	status:	published
resp. depart.:	PP	date of release:	05.2011	revision No.:	1		
doc. type:	LGS	change rep. No.:	00779A	retention period:	10y.		

Global Standard	LESER Global Standard	LGS 4100
	Assembly instructions for types 437, 438, 439, 481	Page 13/41

8.2.2.2 Spindle / spring plate assembly



Illustration	Description	Tool / aid
 <p>Figure 8.2.2.2-1</p>	Put the spring plate in the device and fasten in place with bench vice.	- Bench vice
 <p>Figure 8.2.2.2-2</p>	Put a very small amount of glue on the spindle thread (1 drop on the thread).	Glue DELO ML 5449
 <p>Figure 8.2.2.2-3</p>	Put the spindle thread in the lower spring plate and screw it in until it is finger-tight. Push the pin punch through the spindle hole and screw in finger tight.	Pin punch

public

disclosure cat.:	I	proofread:	KUW	published date:	9/15/11	effect. date:	05.2011
author:	Niehus	released by:	KUW	replaces:	0	status:	published
resp. depart.:	PP	date of release:	05.2011	revision No.:	1		
doc. type:	LGS	change rep. No.:	00779A	retention period:	10y.		

Global Standard	LESER Global Standard Assembly instructions for types 437, 438, 439, 481	LGS 4100
		Page 14/41

8.2.2.3 Assembly installation

Illustration	Description	Tool / aid
 <p>Figure 8.2.2.3-1</p>	Put the ball into the disc assembly and connect to the spindle / spring plate group.	
 <p>Figure 8.2.2.3-2</p>	Visual check: The pin must have some play in the parts through-hole of the disc body; connect with pin.	Hammer Support area for disc assembly

public

disclosure cat.:	I	proofread:	KUW	published date:	9/15/11	effect. date:	05.2011
author:	Niehus	released by:	KUW	replaces:	0	status:	published
resp. depart.:	PP	date of release:	05.2011	revision No.:	1		
doc. type:	LGS	change rep. No.:	00779A	retention period:	10y.		

Global Standard	LESER Global Standard	LGS 4100
	Assembly instructions for types 437, 438, 439, 481	Page 15/41

Illustration	Description	Tool / aid
 <p>Figure 8.2.2.3-3</p>	<p>Install the spring and top spring plate on the spindle.</p>	



public

disclosure cat.:	I	proofread:	KUW	published date:	9/15/11	effect. date:	05.2011
author:	Niehus	released by:	KUW	replaces:	0	status:	published
resp. depart.:	PP	date of release:	05.2011	revision No.:	1		
doc. type:	LGS	change rep. No.:	00779A	retention period:	10y.		

Global Standard	LESER Global Standard	LGS 4100
	Assembly instructions for types 437, 438, 439, 481	Page 16/41

8.2.3 Soft seal 438/481

8.2.3.1 Disc assembly - soft seal

Illustration	Description	Tool / aid
 <p>Figure 8.2.3.1-1</p>	Visual check: Check sealing surface for cleanliness and damage.	
 <p>Figure 8.2.3.1-2</p>	Wet the O-Ring with soapy water.	
 <p>Figure 8.2.3.1-3</p>	Wet the lifting aid with soapy water.	

public

disclosure cat.:	I	proofread:	KUW	published date:	9/15/11	effect. date:	05.2011
author:	Niehus	released by:	KUW	replaces:	0	status:	published
resp. depart.:	PP	date of release:	05.2011	revision No.:	1		
doc. type:	LGS	change rep. No.:	00779A	retention period:	10y.		

Global Standard	LESER Global Standard	LGS 4100
	Assembly instructions for types 437, 438, 439, 481	Page 17/41



Illustration	Description	Tool / aid
 <p>Figure 8.2.3.1-4</p>	Place the O-ring in the lifting aid.	
 <p>Figure 8.2.3.1-5</p>	Press the disc into the lifting aid.	
 <p>Figure 8.2.3.1-6</p>	Mark the material codes of the soft seal into the lifting aid.	Punch numbers Hammer

public

disclosure cat.:	I	proofread:	KUW	published date:	9/15/11	effect. date:	05.2011
author:	Niehus	released by:	KUW	replaces:	0	status:	published
resp. depart.:	PP	date of release:	05.2011	revision No.:	1		
doc. type:	LGS	change rep. No.:	00779A	retention period:	10y.		

Global Standard	LESER Global Standard	LGS 4100
	Assembly instructions for types 437, 438, 439, 481	Page 18/41

8.2.3.2 Spindle / spring plate assembly

Illustration	Description	Tool / aid
 <p>Figure 8.2.3.2-1</p>	Put the spring plate in the assembly device and fasten in place with clamping block.	Clamping block
 <p>Figure 8.2.3.2-2</p>	If necessary, remove excess glue without leaving any residue.	
 <p>Figure 8.2.3.2-3</p>	Put the spindle thread in the lower spring plate and screw it in until it is finger-tight. Push the pin punch through the spindle hole and screw in finger tight.	Pin punch

public

disclosure cat.:	I	proofread:	KUW	published date:	9/15/11	effect. date:	05.2011
author:	Niehus	released by:	KUW	replaces:	0	status:	published
resp. depart.:	PP	date of release:	05.2011	revision No.:	1		
doc. type:	LGS	change rep. No.:	00779A	retention period:	10y.		

Global Standard	LESER Global Standard	LGS 4100
	Assembly instructions for types 437, 438, 439, 481	Page 19/41

8.2.3.3 Assembly installation

Illustration	Description	Tool / aid
 <p>Figure 8.2.3.3-1</p>	<p>Install the spring and top spring plate on the spindle.</p>	





public

disclosure cat.:	I	proofread:	KUW	published date:	9/15/11	effect. date:	05.2011
author:	Niehus	released by:	KUW	replaces:	0	status:	published
resp. depart.:	PP	date of release:	05.2011	revision No.:	1		
doc. type:	LGS	change rep. No.:	00779A	retention period:	10y.		

Global Standard	LESER Global Standard Assembly instructions for types 437, 438, 439, 481	LGS 4100
		Page 20/41

8.2.4 Vulcanised sealing surface 439

8.2.4.1 Disc assembly



Illustration	Description	Tool / aid
 <p>Figure 8.2.4.1-1</p>	Visual check: Check sealing surface for cleanliness and damage.	
 <p>Figure 8.2.4.1-2</p>	Put disc in the inlet side of the lifting aid and screw together hand tight with lock nut.	
 <p>Figure 8.2.4.1-3</p>	Clamp the disc in the assembly device and tighten with the torque wrench. Comply with torque (4 Nm) 	 Special spanner socket Torque wrench Vice

public

disclosure cat.:	I	proofread:	KUW	published date:	9/15/11	effect. date:	05.2011
author:	Niehus	released by:	KUW	replaces:	0	status:	published
resp. depart.:	PP	date of release:	05.2011	revision No.:	1		
doc. type:	LGS	change rep. No.:	00779A	retention period:	10y.		

Global Standard	LESER Global Standard Assembly instructions for types 437, 438, 439, 481	LGS 4100
		Page 21/41

8.2.4.2 Spindle / spring plate assembly



Illustration	Description	Tool / aid
 <p>Figure 8.2.4.2-1</p>	Put the spring plate into the assembly device and fasten in place with clamping block.	Clamping block
 <p>Figure 8.2.4.2-2</p>	Put a very small amount of glue on the spindle thread (1 drop on the thread).	Glue DELO ML 5449
 <p>Figure 8.2.4.2-3</p>	Put the spindle thread in the lower spring plate and screw it in until it is finger-tight. Push the pin punch through the spindle hole and screw in finger tight.	Pin punch

public

disclosure cat.:	I	proofread:	KUW	published date:	9/15/11	effect. date:	05.2011
author:	Niehus	released by:	KUW	replaces:	0	status:	published
resp. depart.:	PP	date of release:	05.2011	revision No.:	1		
doc. type:	LGS	change rep. No.:	00779A	retention period:	10y.		

Global Standard	LESER Global Standard	LGS 4100
	Assembly instructions for types 437, 438, 439, 481	Page 22/41

8.2.4.3 Assembly installation

Illustration	Description	Tool / aid
 <p>Figure 8.2.4.3-1</p>	<p>Put the ball in the disc assembly and connect to the spindle / spring plate group.</p>	
 <p>Figure 8.2.4.3-2</p>	<p>Install the pin centred.</p> <p>Visual check: The pin must have some play in the disc through-hole.</p>	<p>Hammer Support area for disc assembly</p>

public

disclosure cat.:	I	proofread:	KUW	published date:	9/15/11	effect. date:	05.2011
author:	Niehus	released by:	KUW	replaces:	0	status:	published
resp. depart.:	PP	date of release:	05.2011	revision No.:	1		
doc. type:	LGS	change rep. No.:	00779A	retention period:	10y.		

Global Standard	LESER Global Standard	LGS 4100
	Assembly instructions for types 437, 438, 439, 481	Page 23/41

Illustration	Description	Tool / aid
	<p>Install the spring and top spring plate on the spindle.</p> <p>Only for thrust bearings: Spring, top spring plate, thrust bearings, bearing washer. Grease thrust bearings.</p>	<p>Brush Halocarbon (OI-56 S / 60H)</p>

Figure 8.2.4.3-3



public

disclosure cat.:	I	proofread:	KUW	published date:	9/15/11	effect. date:	05.2011
author:	Niehus	released by:	KUW	replaces:	0	status:	published
resp. depart.:	PP	date of release:	05.2011	revision No.:	1		
doc. type:	LGS	change rep. No.:	00779A	retention period:	10y.		

Global Standard	LESER Global Standard	LGS 4100
	Assembly instructions for types 437, 438, 439, 481	Page 24/41

8.3 Assembly of the inlet body and outlet body

8.3.1 Insertion of the spindle / disc assembly

Illustration	Description	Tool / aid
 <p>Figure 8.3.1-1</p>	<p></p> <p>Put the spindle assembly (incl. spring and upper spring plate) in the outlet body. Make sure that the spindle slides smoothly into the guide of the adjusting screw bushing and also the lower spring plate in the outlet body.</p>	

8.3.2 Securing the disc

Illustration	Description	Tool / aid
 <p>Figure 8.3.2-1</p>	<p>Push the splint pin through the hole of the spindle.</p> <p>Lift the spindle with the pin punch.</p> <p>Wedge the splint pin by screwing out the adjusting screw (for following assembly steps).</p>	Pin punch



public

disclosure cat.:	I	proofread:	KUW	published date:	9/15/11	effect. date:	05.2011
author:	Niehus	released by:	KUW	replaces:	0	status:	published
resp. depart.:	PP	date of release:	05.2011	revision No.:	1		
doc. type:	LGS	change rep. No.:	00779A	retention period:	10y.		

Global Standard	LESER Global Standard	LGS 4100
	Assembly instructions for types 437, 438, 439, 481	Page 25/41

8.3.3 Assembly of the inlet body



8.3.3.1 Assembly of inlet body for threaded connector (cylindrical thread)

Illustration	Description	Tool / aid
 <p>Figure 8.3.3.1-1</p>	<p>Visual check of inlet body: Check sealing surface for cleanliness and damage. Grease the thread of the inlet body.</p>	<p>Brush Halocarbon (OI-56 S / 60H)</p>
 <p>Figure 8.3.3.1-2</p>	<p>The disc is in a secured state (see 8.3.2)</p> <p>Screw the inlet body into the outlet body hand tight.</p>	
 <p>Figure 8.3.3.1-3</p>	<p>The disc is in a secured state (see 8.3.2)</p> <p>Clamp the inlet body on the device (if necessary: by using an adapter).</p>	<p>Clamping devices, adapter</p>

public

disclosure cat.:	I	proofread:	KUW	published date:	9/15/11	effect. date:	05.2011
author:	Niehus	released by:	KUW	replaces:	0	status:	published
resp. depart.:	PP	date of release:	05.2011	revision No.:	1		
doc. type:	LGS	change rep. No.:	00779A	retention period:	10y.		

Global Standard	LESER Global Standard	LGS 4100
	Assembly instructions for types 437, 438, 439, 481	Page 26/41





Illustration	Description	Tool / aid
 <p>Figure 8.3.3.1-4</p>	<p>The disc is in a secured state (see 8.3.2)</p>	
 <p>Figure 8.3.3.1-5</p>	<p>Tighten the inlet body with the specified torque (100 Nm). </p>	<p>Torque wrench</p>

public

disclosure cat.:	I	proofread:	KUW	published date:	9/15/11	effect. date:	05.2011
author:	Niehus	released by:	KUW	replaces:	0	status:	published
resp. depart.:	PP	date of release:	05.2011	revision No.:	1		
doc. type:	LGS	change rep. No.:	00779A	retention period:	10y.		

Global Standard	LESER Global Standard	LGS 4100
	Assembly instructions for types 437, 438, 439, 481	Page 27/41

8.3.3.2 Assembly of inlet body for flanged connector (cylindrical thread)

Illustration	Description	Tool / aid
 <p>Figure 8.3.3.2-1</p>	<p>ANSI flange 1/2" 150 lbs only: Before gluing the inlet body to the inlet nozzle, make sure that the sealing surface and the sealing strip are lightly greased with Halocarbon.</p>	<p>Halocarbon (OI-56 S / 60H)</p>
 <p>Figure 8.3.3.2-2</p>	<p> ANSI flange 1/2" 150 lbs only: Inlet body screwed together with the inlet nozzle.</p>	
 <p>Figure 8.3.3.2-3</p>	<p>Visual check: Check sealing surface for cleanliness and damage.</p> <p>The disc is in a secured state (see 8.3.2)</p> <p>Grease the inlet body and screw it into the outlet body.</p>	<p>Brush Halocarbon (OI-56 S / 60H) Glue DELO CA 2106</p>

public

disclosure cat.:	I	proofread:	KUW	published date:	9/15/11	effect. date:	05.2011
author:	Niehus	released by:	KUW	replaces:	0	status:	published
resp. depart.:	PP	date of release:	05.2011	revision No.:	1		
doc. type:	LGS	change rep. No.:	00779A	retention period:	10y.		

Global Standard	LESER Global Standard	LGS 4100
	Assembly instructions for types 437, 438, 439, 481	Page 28/41



Figure 8.3.3.2-4

Tighten the inlet body with the specified torque (100 Nm).

Pin punch
Torque wrench

public

disclosure cat.:	I	proofread:	KUW	published date:	9/15/11	effect. date:	05.2011
author:	Niehus	released by:	KUW	replaces:	0	status:	published
resp. depart.:	PP	date of release:	05.2011	revision No.:	1		
doc. type:	LGS	change rep. No.:	00779A	retention period:	10y.		

Global Standard	LESER Global Standard	LGS 4100
	Assembly instructions for types 437, 438, 439, 481	Page 29/41

8.3.4 Assembly of the outlet flange

8.3.4.1 Assembly of outlet adapter with cylindrical thread



Illustration	Description	Tool / aid
 <p>Figure 8.3.4.1-1</p>	<p>Grease the sealing lip and thread of the outlet adapter. Fit the outlet flange over the outlet adapter, screw the adapter into the outlet body and tighten it.</p> <p>Tighten the outlet adapter with the specified torque (100 Nm).</p>	<p>Brush Halocarbon (OI-56 S / 60H) Torque wrench</p>

public

disclosure cat.:	I	proofread:	KUW	published date:	9/15/11	effect. date:	05.2011
author:	Niehus	released by:	KUW	replaces:	0	status:	published
resp. depart.:	PP	date of release:	05.2011	revision No.:	1		
doc. type:	LGS	change rep. No.:	00779A	retention period:	10y.		

Global Standard	LESER Global Standard	LGS 4100
	Assembly instructions for types 437, 438, 439, 481	Page 30/41

8.3.4.2 Assembly of outlet adapter with a conical thread (NPT)

Illustration	Description	Tool / aid
 <p>Figure 8.3.4.2-1</p>	Apply sealing tape to the thread of the outlet flange.	Sealing tape
 <p>Figure 8.3.4.2-2</p>	Screw the outlet adapter into the outlet body and tighten it.	

public

disclosure cat.:	I	proofread:	KUW	published date:	9/15/11	effect. date:	05.2011
author:	Niehus	released by:	KUW	replaces:	0	status:	published
resp. depart.:	PP	date of release:	05.2011	revision No.:	1		
doc. type:	LGS	change rep. No.:	00779A	retention period:	10y.		

Global Standard	LESER Global Standard	LGS 4100
	Assembly instructions for types 437, 438, 439, 481	Page 31/41

8.4 Adjusting the set pressure

Illustration	Description	Tool / aid
	<p>Secure the spindle with splint pin against turning when adjusting the adjusting screw.</p> <p>Pressurise the valve and adjust to the set pressure with the adjusting screw in accordance with the specification.</p> <p>Check whether the valve opens at the set pressure. The set pressure of the valve has been reached when you can hear air escaping. Full opening must be achieved.</p> <p>If the valve opens outside the stipulated set pressure tolerance, the adjusting screw must be adjusted again.</p> <p>→ Turning in a clockwise direction causes the valve to open at higher pressure. → Turning in a counter-clockwise direction causes the valve to open at lower pressure.</p> <p>When resetting the adjusting screw, first of all release the pressure.</p> <p>Remark: In case of 437 with d0=6mm, LGS 3614 must be considered.</p>	<p>Pin punch Open-end spanner Pressure gauge</p>

Figure 8.4-1

public

disclosure cat.:	I	proofread:	KUW	published date:	9/15/11	effect. date:	05.2011
author:	Niehus	released by:	KUW	replaces:	0	status:	published
resp. depart.:	PP	date of release:	05.2011	revision No.:	1		
doc. type:	LGS	change rep. No.:	00779A	retention period:	10y.		

Global Standard	LESER Global Standard	LGS 4100
	Assembly instructions for types 437, 438, 439, 481	Page 32/41

8.5 Testing and documenting the seat tightness.

Illustration	Description	Tool / aid
 <p>Figure 8.5-1</p>	<p>Raise the valve to its set pressure 3 times. After the 3rd opening, throttle the valve from the set pressure to the test pressure. Screw the test cap on to the outlet body. Seal the valve outlet with the test plug thereby connecting it to the water tank. Adjust the valve to the given test pressure.</p> <p>Check the functional seal tightness according to the order specifications and LGS 0201.</p> <p>If the seal tightness is not met, then enter the number of bubbles that are counted in the fields. If the seal tightness has not been met after 3 attempts, then initiate a fault report. If the seal tightness has been met in accordance with the specifications, then document the results in Report 1.3 "Number of Bubbles".</p> <p>Unscrew test cap</p>	<p>Kellog test assembly device</p>



public

disclosure cat.:	I	proofread:	KUW	published date:	9/15/11	effect. date:	05.2011
author:	Niehus	released by:	KUW	replaces:	0	status:	published
resp. depart.:	PP	date of release:	05.2011	revision No.:	1		
doc. type:	LGS	change rep. No.:	00779A	retention period:	10y.		

Global Standard	LESER Global Standard	LGS 4100
	Assembly instructions for types 437, 438, 439, 481	Page 33/41

8.6 Assembly of the cap and lever

8.6.1 Assembly of cap H2



Illustration	Description	Tool / aid
 <p>Figure 8.6.1-1</p>	<p>Grease the thread and sealing lip of cap H2. Put on the E-CTFE sealing ring if it is shown in the parts list.</p> <p>Caution: The sealing ring may only be used once. If it is necessary to disassemble the cap, the sealing ring must be replaced.</p>	<p>Brush Halocarbon (OI-56 S / 60H)</p>
 <p>Figure 8.6.1-2</p>	<p>Screw the cap on and tighten it with a spanner (torque as per LGS 3322).</p>	<p>Torque wrench</p>

public

disclosure cat.:	I	proofread:	KUW	published date:	9/15/11	effect. date:	05.2011
author:	Niehus	released by:	KUW	replaces:	0	status:	published
resp. depart.:	PP	date of release:	05.2011	revision No.:	1		
doc. type:	LGS	change rep. No.:	00779A	retention period:	10y.		

Global Standard	LESER Global Standard	LGS 4100
	Assembly instructions for types 437, 438, 439, 481	Page 34/41



8.6.2 Assembly of lever H4

Illustration	Description	Tool / aid
 <p>Figure 8.6.2-1</p>	Roll the O-ring onto the spindle cap.	
 <p>Figure 8.6.2-2</p>	Put the spindle cap onto the spindle and connect with a cylinder pin.	
 <p>Figure 8.6.2-3</p>	<p>Grease the O-ring well (1).</p> <p>Grease the threads of the spindle cap (2).</p> <p>Put on the E-CTFE sealing ring if it is shown in the parts list.</p> <p>Caution: The sealing ring may only be used once. If it is necessary to disassemble the cap, the sealing ring must be replaced.</p>	<p>(1) Klübersynth UH 14-151 / 60H</p> <p>(2) Halocarbon (OI-56 S / 60H)</p>

public

disclosure cat.:	I	proofread:	KUW	published date:	9/15/11	effect. date:	05.2011
author:	Niehus	released by:	KUW	replaces:	0	status:	published
resp. depart.:	PP	date of release:	05.2011	revision No.:	1		
doc. type:	LGS	change rep. No.:	00779A	retention period:	10y.		





Global Standard	LESER Global Standard Assembly instructions for types 437, 438, 439, 481	LGS 4100
		Page 35/41

Illustration	Description	Tool / aid
 <p>Figure 8.6.2-4</p>	Grease the thread and sealing lip of the lever cover.	Brush Halocarbon (OI-56 S / 60H)
 <p>Figure 8.6.2-5</p>	Screw the lever cover onto the thread of the outlet body and tighten using approx. 60 - 75 Nm.	Torque wrench
 <p>Figure 8.6.2-6</p>	Fit the pin into the hole of the lever cover and the slot of the spindle cap and secure it with the retaining clip.	

public

disclosure cat.:	I	proofread:	KUW	published date:	9/15/11	effect. date:	05.2011
author:	Niehus	released by:	KUW	replaces:	0	status:	published
resp. depart.:	PP	date of release:	05.2011	revision No.:	1		
doc. type:	LGS	change rep. No.:	00779A	retention period:	10y.		

Global Standard	LESER Global Standard	LGS 4100
	Assembly instructions for types 437, 438, 439, 481	Page 36/41

Illustration	Description	Tool / aid
 <p>Figure 8.6.2-7</p>	<p>Press the spindle cap down after assembly.</p>	
 <p>Figure 8.6.2-8</p>	<p>Grease the threads of the lever cap and install it. Attention: left-handed thread</p>	<p>Brush Halocarbon (OI-56 S / 60H)</p>
 <p>Figure 8.6.2-9</p>	<p>Screw in cylinder pin / nut is flush when closed. Set lever to "closed" / the inscription "CLOSED" can be read on the cap limit stop. </p> <p>Check the lever after assembly to make sure that it works (release compressed air with each lever).</p>	<p>Flat-tip screwdriver</p>

public

disclosure cat.:	I	proofread:	KUW	published date:	9/15/11	effect. date:	05.2011
author:	Niehus	released by:	KUW	replaces:	0	status:	published
resp. depart.:	PP	date of release:	05.2011	revision No.:	1		
doc. type:	LGS	change rep. No.:	00779A	retention period:	10y.		

Global Standard	LESER Global Standard Assembly instructions for types 437, 438, 439, 481	LGS 4100
		Page 37/41



8.6.3 Assembly of lever H3

Illustration	Description	Tool / aid
 <p>Figure 8.6.3-1</p>	Individual parts of the assembly	
 <p>Figure 8.6.3-2</p>	Place the O-ring in the groove of the lever cover.	
 <p>Figure 8.6.3-3</p>	Put the spindle cap onto the spindle and connect with a cylinder pin.	

public

disclosure cat.:	I	proofread:	KUW	published date:	9/15/11	effect. date:	05.2011
author:	Niehus	released by:	KUW	replaces:	0	status:	published
resp. depart.:	PP	date of release:	05.2011	revision No.:	1		
doc. type:	LGS	change rep. No.:	00779A	retention period:	10y.		

Global Standard	LESER Global Standard	LGS 4100
	Assembly instructions for types 437, 438, 439, 481	Page 38/41

Illustration	Description	Tool / aid
 <p>Figure 8.6.3-4</p>	<p>Grease the thread and sealing lip of the lever cover.</p>	<p>Brush Halocarbon (Oil 56 S / 60H)</p>
 <p>Figure 8.6.3-5</p>	<p>Screw the lever cover onto the thread of the outlet body and tighten it using approx. 60 - 75 Nm. Pull up the spindle cap and install the knob with the pin and secure with the retaining clip. Press the knob down after assembly.</p>	<p>Torque wrench</p>



public

disclosure cat.:	I	proofread:	KUW	published date:	9/15/11	effect. date:	05.2011
author:	Niehus	released by:	KUW	replaces:	0	status:	published
resp. depart.:	PP	date of release:	05.2011	revision No.:	1		
doc. type:	LGS	change rep. No.:	00779A	retention period:	10y.		

Global Standard	LESER Global Standard	LGS 4100
	Assembly instructions for types 437, 438, 439, 481	Page 39/41

8.7 Testing the seal tightness to the outside



8.7.1 Testing the seal tightness to the outside (threaded valve)

Illustration	Description	Tool / aid
 <p>Figure 8.7.1-1</p>	Seal the valve at the inlet with a sealing cap.	Sealing cap
 <p>Figure 8.7.1-2</p>	Install a test connector to the outlet.	Test connector

public

disclosure cat.:	I	proofread:	KUW	published date:	9/15/11	effect. date:	05.2011
author:	Niehus	released by:	KUW	replaces:	0	status:	published
resp. depart.:	PP	date of release:	05.2011	revision No.:	1		
doc. type:	LGS	change rep. No.:	00779A	retention period:	10y.		

Global Standard	LESER Global Standard	LGS 4100
	Assembly instructions for types 437, 438, 439, 481	Page 40/41

Illustration	Description	Tool / aid
 <p>Figure 8.7.1-3</p>	<p>Clamp the outlet side of the valve in the test assembly device and apply 6 bar of pressure.</p>	
 <p>Figure 8.7.1-4</p>	<p>Pressure testing by immersion: Check whether any bubbles can be seen on the outside contour of the safety valve. If the seal tightness is good (no bubbles), document the test result. If there are any leaks, check the affected sealing surfaces and seals for damage and then test again. Dry the valve with compressed air.</p>	

public

disclosure cat.:	I	proofread:	KUW	published date:	9/15/11	effect. date:	05.2011
author:	Niehus	released by:	KUW	replaces:	0	status:	published
resp. depart.:	PP	date of release:	05.2011	revision No.:	1		
doc. type:	LGS	change rep. No.:	00779A	retention period:	10y.		

Global Standard	LESER Global Standard	LGS 4100
	Assembly instructions for types 437, 438, 439, 481	Page 41/41

8.7.2 Testing the seal tightness to the outside (flanged valve)

Illustration	Description	Tool / aid
 <p>Figure 8.7.2-1</p>	<p>Clamp the outlet side of the valve to the test bench. Pressurise the valve with 6 bar.</p> <p>Wet the valve with leak detector on the interconnection points and the outlet area. If the seal tightness is good (no bubbles), document the test result. If there are any leaks, check the affected sealing surfaces and seals for damage and then test again. Dry the valve with compressed air.</p>	

8.8 Sealing the valve

Illustration	Description	Tool / aid
 <p>Figure 8.8-1</p>	<p>Connect the sealing wire closely by using the shortest path. Seal the lever, or alternatively cap H2 to the outlet body.</p>	

public

disclosure cat.:	I	proofread:	KUW	published date:	9/15/11	effect. date:	05.2011
author:	Niehus	released by:	KUW	replaces:	0	status:	published
resp. depart.:	PP	date of release:	05.2011	revision No.:	1		
doc. type:	LGS	change rep. No.:	00779A	retention period:	10y.		