

Global Standard	LESER Global Standard Disassembly Accessories	LGS 4128
		Page 1/10

## Content

<b>1</b>	<b>General information for disassembling the POSV accessories .....</b>	<b>2</b>
<b>2</b>	<b>Purpose .....</b>	<b>2</b>
<b>3</b>	<b>Competences .....</b>	<b>2</b>
<b>4</b>	<b>Scope .....</b>	<b>2</b>
<b>5</b>	<b>Disclaimer.....</b>	<b>2</b>
<b>6</b>	<b>Qualified fitting personnel.....</b>	<b>2</b>
<b>7</b>	<b>Remarks.....</b>	<b>2</b>
<b>8</b>	<b>Basic safety guidelines .....</b>	<b>3</b>
<b>9</b>	<b>Disassembly instructions.....</b>	<b>6</b>

protected

disclosure cat.:	II	proofread:	Cal	published date:	tbd	effect. date:	02/12
author:	AW	released by:	KUW	replaces:	initial	status:	published
resp. depart.:	PP	date of release:	YY/MM	revision No.:	0		
doc. type:	LGS	change rep. No.:		retention period:	10y.		

## 1 General information for disassembling the POSV accessories

### 2 Purpose

The documentation describes the disassembly of the POSV accessories. The description contains every single working step, supplies, tools and appliances.

### 3 Competences

The generation, maintenance and distribution of the documentation takes place in the organisation department. The defaults will be generated by the technical department in consultation with the final assembly department and production planning department.

### 4 Scope

This document must be applied to the assembling of a Pilot Operated Safety Valve with accessories in agencies and subsidiaries of LESER GmbH & Co. KG, customers and independent service center.

### 5 Disclaimer

LESER puts in a great deal of effort into making up-to-date and correct documentation available. Nevertheless, LESER GmbH & Co. KG gives no guarantee that the recommended actions presented here are entirely correct and error free. This document is to be applied exclusively to the specified type. LESER GmbH & Co. KG declines any liability or responsibility for the correctness and completeness of the content.

LESER GmbH & Co. KG reserves the right to change the information contained in this document, which is for the products of LESER GmbH & Co. KG and is intended for LESER subsidiaries, at any time and without prior announcement.

LESER GmbH & Co. KG is available to the users of this document to provide additional information.

### 6 Qualified fitting personnel

LESER safety valves may only be dismantled by trained or qualified fitters. The qualifications must be obtained through the appropriate training measures.

### 7 Remarks



Gloves must be worn during the entire dismantling process.

protected

disclosure cat.:	II	proofread:	Cal	published date:	tbd	effect. date:	02/12
author:	AW	released by:	KUW	replaces:	initial	status:	published
resp. depart.:	PP	date of release:	YY/MM	revision No.:	0		
doc. type:	LGS	change rep. No.:		retention period:	10y.		

## 8 Basic safety guidelines

### Dangerous media

Poisoning, caustic burns, burns, injuries

- Use suitable protective devices
- Use suitable collecting tanks.
- Wear suitable protective equipment.

### Foreign bodies in the safety valve

Danger from failure of safety valve or leaks

- Flush the system before installation of a safety valve.
- Check the safety valve for foreign objects.
- Remove foreign objects

### Bug screen is damaged or missing (B or option)

Dirt, objects or insects get into the safety valve. Danger from malfunction of the safety valve.

- Install the bug screen correctly.
- Check the bug screen regularly.

### Ambient temperature is too high

Material expansion. Danger from malfunction of the safety valve.

### Ambient temperature is too low

Icing, freezing vapours, reduced flow rate due to congealing media. Danger from functional disruption of the safety valve.

### Abrasive or corrosive media

Moving parts jam or become stuck. Danger from functional disruption of the safety valve.

- Service the safety valve after each time it opens.

### Media with high proportion of particles (only B)

disclosure cat.:	II	proofread:	Cal	published date:	tbd	effect. date:	02/12
author:	AW	released by:	KUW	replaces:	initial	status:	published
resp. depart.:	PP	date of release:	YY/MM	revision No.:	0		
doc. type:	LGS	change rep. No.:		retention period:	10y.		

protected

Deposits and clogging. Danger from malfunction of the safety valve.

- Use a filter with the correct mesh size.
- Use additional filters to increase the filter capacity.

### Residual media in the safety valve

Poisoning, caustic burns, burns, injuries

- Wear suitable protective equipment.
- Remove residual media

### WARNING

#### Leaky safety valve

Danger from leaking media due to damaged gaskets and sealing surfaces.

- Protect the safety valve against vibrations and blows especially during transport and installation.
- Check safety valve regularly for leaks.

#### Open bonnet or spindle guides

Danger from leaking media

- Make sure that no danger can arise from leaking media.
- Keep a safe distance.
- Wear suitable protective equipment.

### CAUTION

#### Hot medium

Burns or scalding.

- Wear suitable protective equipment.

#### Hot surfaces

Burns.

- Wear suitable protective equipment.

#### Aggressive medium

Caustic burns.

- Wear suitable protective equipment.

#### Open bonnet or spindle guides

disclosure cat.:	II	proofread:	Cal	published date:	tbd	effect. date:	02/12
author:	AW	released by:	KUW	replaces:	initial	status:	published
resp. depart.:	PP	date of release:	YY/MM	revision No.:	0		
doc. type:	LGS	change rep. No.:		retention period:	10y.		

protected

Pinching danger from moving parts.

- Install suitable safeguards.

### Sharp edges and burrs

Danger of injury.

- Wear safety gloves.
- Handle the safety valve carefully

### High noise emission

Hearing damage.

Wear ear protection.

protected

disclosure cat.:	II	proofread:	Cal	published date:	tbd	effect. date:	02/12
author:	AW	released by:	KUW	replaces:	initial	status:	published
resp. depart.:	PP	date of release:	YY/MM	revision No.:	0		
doc. type:	LGS	change rep. No.:		retention period:	10y.		

## 9 Disassembly instructions

### 9.1 Disassembly of the FTC (Field Test Connector)

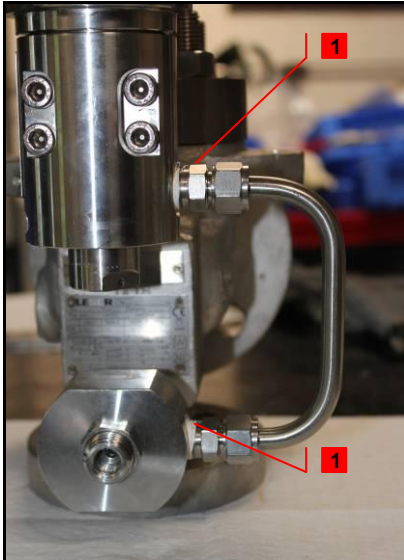

#### 1. Steps – Descriptions

Pay special attention, when opening a closed system regarding any remaining critical media in tubes



**Option A: Remove complete FTC including pitot tube**

**1** Screw off compression fitting and remove tube



Make sure that valve body is not connected to inlet pipe

**2** Remove complete FTC by loosen fastener (FTC)



Pull out pitot tube and tube (depends on nominal size)

**3 4** Loosen lock nut and pull out pressure ring (FTC)



**5** Unscrew body (FTC) and fastener (FTC)

**6** Pull out piston



**7** Remove O-rings



#### 2. Supplies

None

#### 3. Tools

Hook tool for O-rings  
Open-end wrench acc. to LID

#### 4. Appliance

Test bench

protected

disclosure cat.:	II	proofread:	Cal	published date:	tbd	effect. date:	02/12
author:	AW	released by:	KUW	replaces:	initial	status:	published
resp. depart.:	PP	date of release:	YY/MM	revision No.:	0		
doc. type:	LGS	change rep. No.:		retention period:	10y.		



## 9.2 Disassembly of the FTC (Field Test Connector)

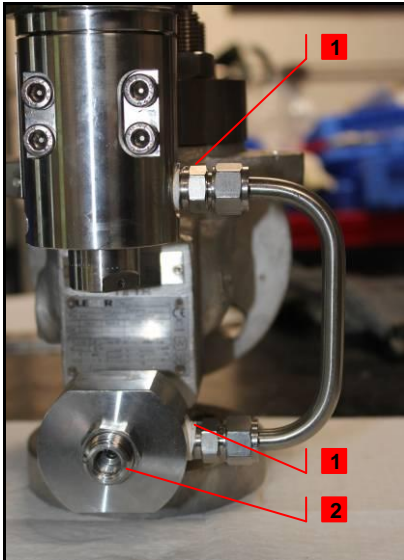

### 1. Steps – Descriptions



Pay special attention, when opening a closed system regarding any remaining critical media in tubes

#### Option B: Remove FTC exclusive pitot tube

**1** Screw off the compression fitting and remove the tube



Make sure that fastener (FTC) stays tightened during disassembly in order that pitot tube stays tightened!

**2** Loosen lock nut (FTC)

**3** Pull out pressure ring (FTC)

**4** Unscrew body (FTC) by securing fastener (FTC) with a second open-end wrench

**5** Pull out piston (FTC)

**6** Remove O-rings

### 2. Supplies

None

### 3. Tools

Hook tool for O-rings  
Open-end wrench acc. to LID

### 4. Appliance

Test bench

protected

disclosure cat.:	II	proofread:	Cal	published date:	tbd	effect. date:	02/12
author:	AW	released by:	KUW	replaces:	initial	status:	published
resp. depart.:	PP	date of release:	YY/MM	revision No.:	0		
doc. type:	LGS	change rep. No.:		retention period:	10y.		

## 9.3 Disassembly of the pilot supply filter

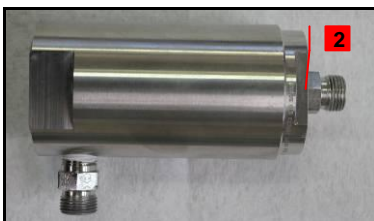
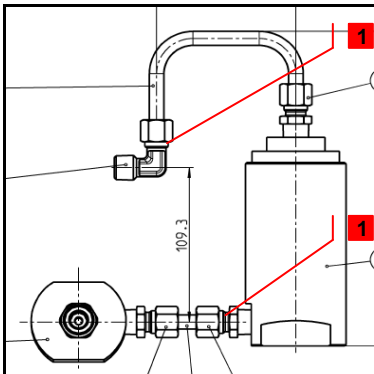

### 1. Steps – Descriptions

**1** Loosen compression fitting and remove tube between pilot and pilot supply filter and between pilot supply filter and FTC or main valve

**2** Loosen (upper part) housing with open-end wrench and remove including cartridge filter

**3** Pull cartridge filter out of (upper part) housing

Remove perforated disc

**4** Remove O-ring of cartridge filter and (lower part) filter housing

**5** Remove compression fittings of (lower part) housing and (upper part) housing - if necessary

### 2. Supplies

None

### 3. Tools

Open-end wrench acc. to LID  
Hook tool for O-rings

### 4. Appliance

None

protected

disclosure cat.:	II	proofread:	Cal	published date:	tbd	effect. date:	02/12
author:	AW	released by:	KUW	replaces:	initial	status:	published
resp. depart.:	PP	date of release:	YY/MM	revision No.:	0		
doc. type:	LGS	change rep. No.:		retention period:	10y.		



## 9.4 Disassembly of the manual blowdown

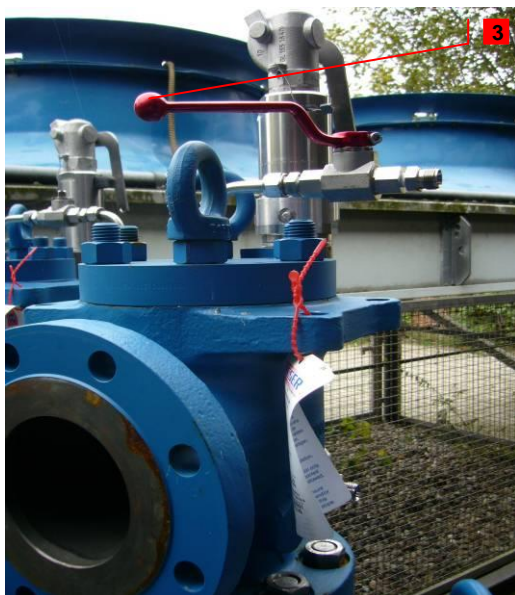
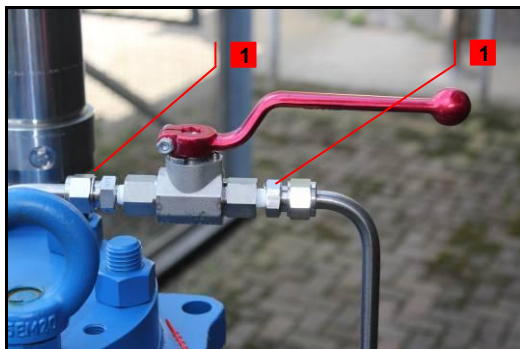
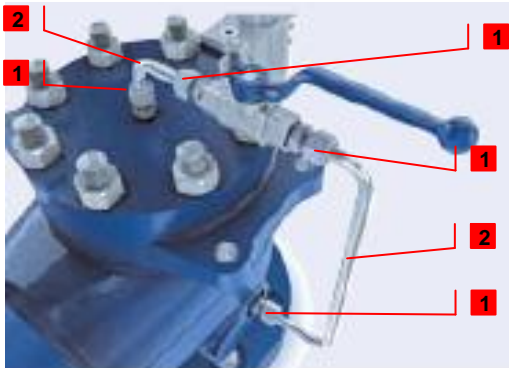

### 1. Steps – Descriptions

#### Option A: Manual blowdown into main valve outlet



Make sure that sealing tape is accurately removed from threads and do not fall into dome in any case

- 1** Loosen compression fittings
- 2** Remove L- tube (MBI.2) and U- tube (MBI.1) and male end fittings of top plate, ball valve and body
- 3** Option B: Manual blowdown into atmosphere

- 1** Loosen compression fittings
- 2** Remove L- tube (MBI.2) and male fittings of top plate and ball valve

### 2. Supplies

None

### 3. Tools

Open-end wrench acc. to LID

### 4. Appliance

None

protected

disclosure cat.:	II	proofread:	Cal	published date:	tbd	effect. date:	02/12
author:	AW	released by:	KUW	replaces:	initial	status:	published
resp. depart.:	PP	date of release:	YY/MM	revision No.:	0		
doc. type:	LGS	change rep. No.:		retention period:	10y.		

## 9.5 Disassembly of the remote sensing

### 1. Steps – Descriptions



**Make sure that sealing tape is accurately removed from threads and do not fall into dome in any case**

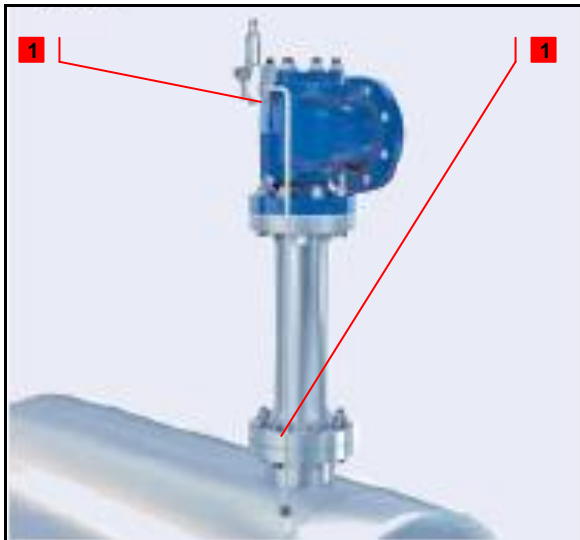

**1** Loosen compression fittings and remove tube and remove male fittings

protected

### 2. Supplies

None

### 3. Tools

Open-end wrench acc. to LID

### 4. Appliance

None

disclosure cat.:	II	proofread:	Cal	published date:	tbd	effect. date:	02/12
author:	AW	released by:	KUW	replaces:	initial	status:	published
resp. depart.:	PP	date of release:	YY/MM	revision No.:	0		
doc. type:	LGS	change rep. No.:		retention period:	10y.		